

Bi-fold Door ORDER FORM

Contact Details:

Company Name: _____

Contact: _____

Address: _____

Postcode: _____

Telephone: _____

Fax: _____

Email: _____

Reference _____

Delivery

Collection

Delivery £15 per sash

Date Required _____

Standard Turnaround 7 Day.

3 & 4 Day Turnaround extra £10 per sash

Opening Configuration:

See reverse for option choices
Bi-Fold Option No. (viewed from outside)

Open Out

fig1.	fig2.	fig3.
-------	-------	-------

Open In

How to configure: Example code 651 (Opening out)

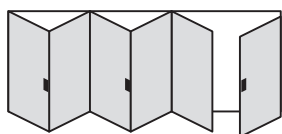

Three figure code: (see reverse)
Total number of sashes 6
Sashes that slide/open to left 5
Sashes that slide/open to right 1

Colours:

	Glazed	Unglazed
White	<input type="checkbox"/> £329 per sash	<input type="checkbox"/> £286 per sash
Foil on White	<input type="checkbox"/> £415 per sash	<input type="checkbox"/> £380 per sash
Foil on Foil	<input type="checkbox"/> £465 per sash	<input type="checkbox"/> £430 per sash
Cream <input type="checkbox"/>	Green <input type="checkbox"/>	Black <input type="checkbox"/>
Grey <input type="checkbox"/>	Golden Oak <input type="checkbox"/>	Rosewood <input type="checkbox"/>

Sizes:

Overall Width including any extra Add Ons (mm)

Overall Frame Height including Cill & any extra Add Ons (mm)

- Please Note: All doors are manufactured and supplied with a 25mm Add On fitted to top & bottom of the frame to accommodate tracks.
- A 10mm gap must be left between your frame size and opening
- ALL PRICES EXCLUDE VAT.

Handle Colours / Locks

White (as standard)

Brown

Silver

ABS Lock £45

Confirmation of Order

Today's Date _____

Price +VAT £ _____

Signature _____

Total Price £ _____

NB Orders can only be processed with a 50% deposit (card or cash) and the balance must be cleared prior to delivery/collection

Standard Threshold (mm)

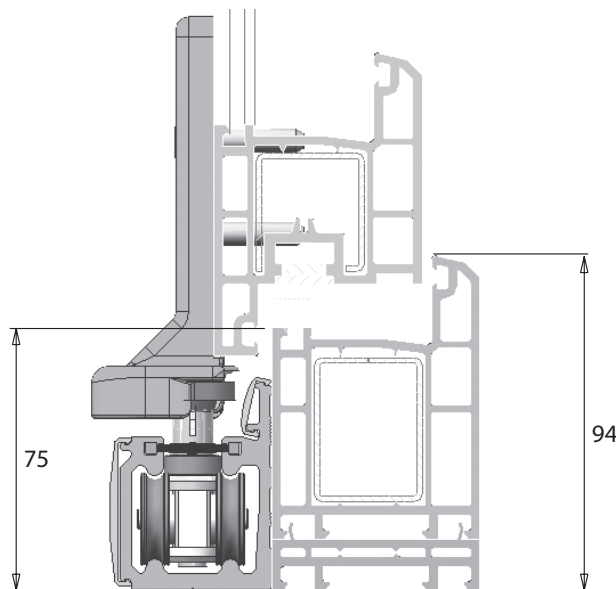

Low Threshold (mm) (OPENING IN ONLY)

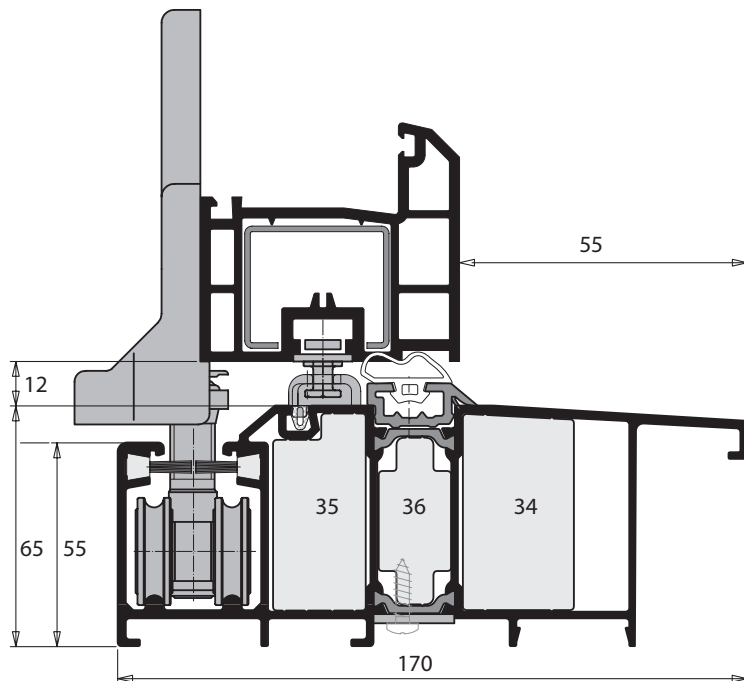

Cills Add ons & Thresholds

Frame Add Ons			PVCu Cill			
15mm	25mm	40mm	No Cill	85mm	150mm	180mm
<input type="checkbox"/>	<input type="checkbox"/>	<input type="checkbox"/>	<input type="checkbox"/>	<input type="checkbox"/>	<input type="checkbox"/>	<input type="checkbox"/>
			Threshold			
<input type="checkbox"/>	<input type="checkbox"/>	<input type="checkbox"/>	<input type="checkbox"/> Standard			
<input type="checkbox"/>	<input type="checkbox"/>	<input type="checkbox"/>	+£POA per sash <input type="checkbox"/> Low Aluminium			

Door Options (Please use the relevant door option codes below when completing your order form - Thankyou)

Option 220  2 sash
2 opening to left
0 opening to right

Option 330  3 sash
3 opening to left
0 opening to right

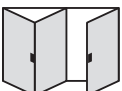
Option 321  3 sash
2 opening to left
1 opening to right

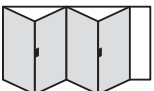
Option 440  4 sash
4 opening to left
0 opening to right

Option 431  4 sash
3 opening to left
1 opening to right

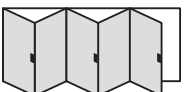
Option 550  5 sash
5 opening to left
0 opening to right

Option 532  5 sash
3 opening to left
2 opening to right

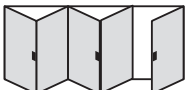
Option 541  5 sash
4 opening to left
1 opening to right

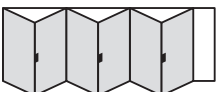
Option 660  6 sash
6 opening to left
0 opening to right

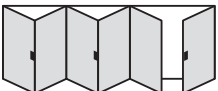
Option 651  6 sash
5 opening to left
1 opening to right

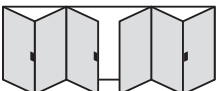
Option 633L  6 sash
3 opening to left
3 opening to right

Master door on left

Option 202  2 sash
0 opening to left
2 opening to right

Option 303  3 sash
0 opening to left
3 opening to right

Option 312  3 sash
1 opening to left
2 opening to right

Option 404  4 sash
4 opening to right
0 opening to left

Option 413  4 sash
1 opening to left
3 opening to right

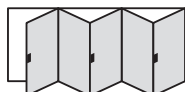
Option 505  5 sash
5 opening to right
0 opening to left

Option 523  5 sash
2 opening to left
3 opening to right

Option 514  5 sash
1 opening to left
5 opening to right

Option 606  6 sash
6 opening to right
0 opening to left

Option 615  6 sash
1 opening to left
5 opening to right

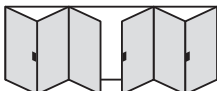
Option 633R  6 sash
3 opening to left
3 opening to right

Master door on right

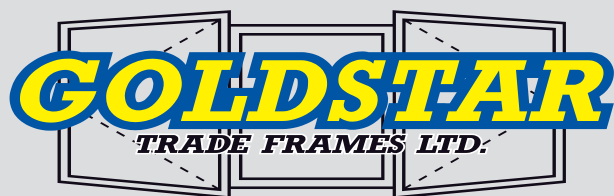

Quality PVCu Products

FAX YOUR ORDER TO:
01922 744 152

All Prices +VAT

All options are viewed from the outside

Maximum height for all doors is 2400mm.

Maximum overall width for Bi-fold door set is 5400mm.

7 pane bi folds available on request.

We reserve the right to alter specifications and descriptions without prior notice as part of our policy of continuous development E&OE

Bi-Folding Door Size Limitations

Option	Min. Width	Max. Width
220	1200	1800
330	1720	2700
321	1720	2700
440	3000	3600
431	2250	3600
550	2780	4500
532	2780	4500
541	2780	4500
660	3300	5400
651	3300	5400
633	3300	5400

Note: Maximum and minimum sizes are guidelines. However, glazed sash weights must not exceed 80kg.

E&OE